

Bellows sealed stop valves

for leak free operation



spirax
/sarco

Bellows sealed stop valves for zero emissions and improved efficiency

Spirax Sarco's range of bellows sealed stop valves provides an environmentally sound solution to on/off stop valve needs.

The bellows sealed design ensures stem seal leaks are totally eliminated, meeting the most stringent worldwide emissions legislation. This capability is vital to maintain plant safety, save energy and promote a cleaner environment. Zero emissions are guaranteed.

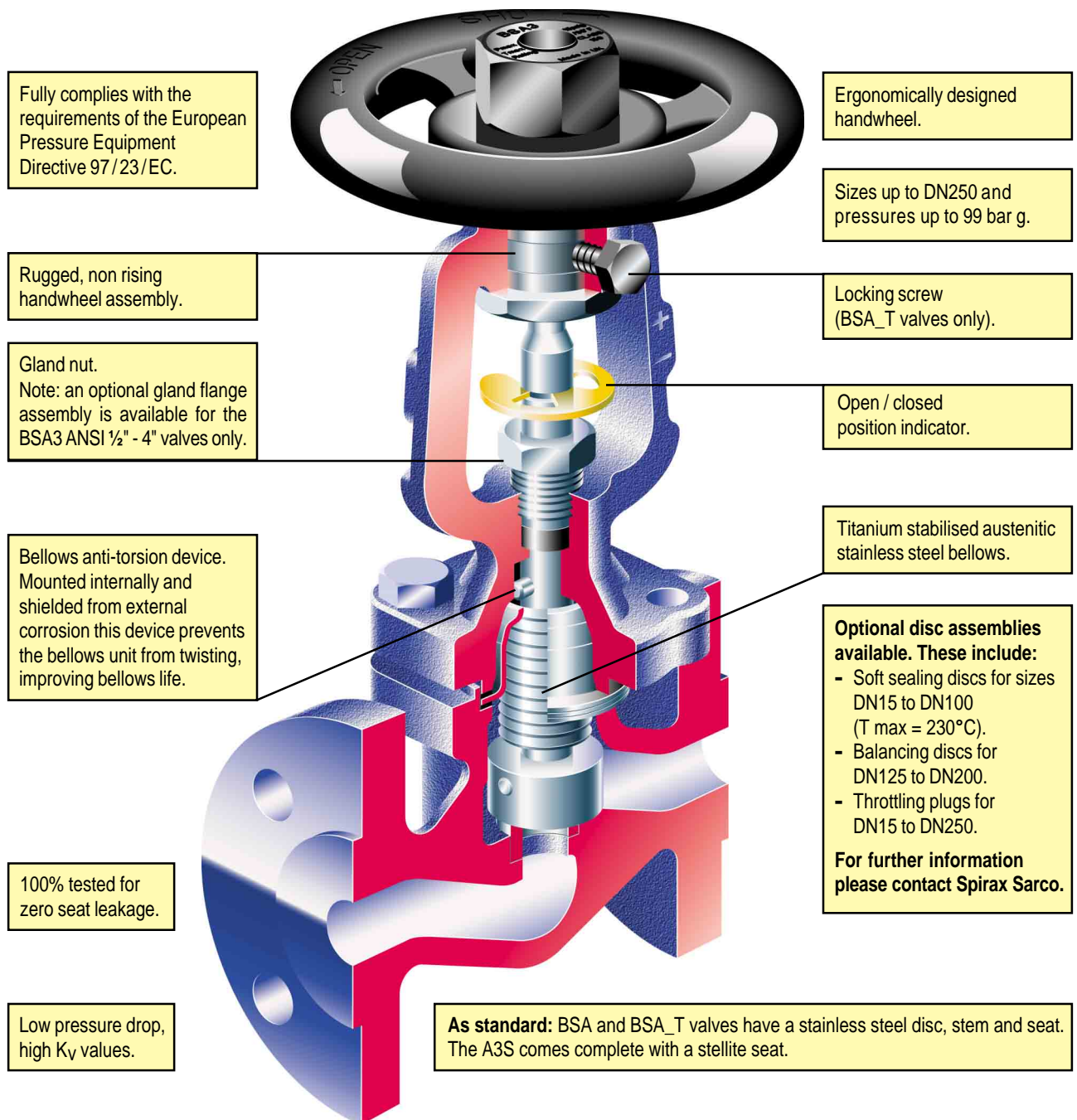

User benefits

- Eliminates fugitive emissions - environmentally friendly and energy efficient.
- Easy to operate.
- Long valve life.
- No ongoing maintenance required.
- Fully complies with the requirements of the European Pressure Equipment Directive 97/23/EC.
- Spirax Sarco's guarantee of worldwide technical support, knowledge and service.

Product features

Long life: Bellows sealed construction offers trouble free operation and the fatigue life of the bellows is designed to meet the latest international standards. In the unlikely event of a bellows failure, a precautionary second seal exists to prevent leaks.

Maintenance free: Not only do the BSA valves eliminate stem seal emissions, they are virtually maintenance free. The procedure for changing internals is rapid and simple. All Spirax Sarco gaskets are asbestos free.

Robust: The BSA valves are unaffected by vibration and will operate over a wide range of pressures and temperatures.

Throttling plug: The new BSA_T offers a throttling plug as opposed to the standard flat disc. The throttling plug allows manual regulation to adjust line pressure and flow, it can also be used as a 'crude' control valve or a substitute for 'bypass' lines. The throttling plug version also benefits from having twin ply bellows which will extend the products service life. Those valves fitted with a throttling plug have a locking screw as standard, enabling the user to lock the valve in the throttling position.

The stainless steel versions, being more likely to be used in corrosive environments, have been fitted with a grease nipple to enable simple lubrication of the stem and bonnet bushes.

Process applications

Bellows sealed stop valves are suitable for use on a wide variety of industrial and process fluids and gases such as steam, air, thermal fluids, oils, hot water and cold water applications.

Ranging from DN15 to DN250 and rated up to PN40, ANSI 300 and Class 800; with flanged, screwed and socket weld connections, there is a valve to meet most process applications.

Isolation applications include: Steam and condensate, process fluids, hot and cold water systems, hot oil systems, toxic fluids, compressed air and other gases, water / glycol systems and thermal fluid systems e.g. Dowtherm*, Santotherm*, Thermex*, Therminol*, Ucon* (*Registered trademarks).

Throttling applications include: Balancing lines, bypass lines and 'crude' control valve substitute.

Bellows sealed stop valve options

Body/bonnet material	Type	Valve trim					Bellows				
		Conical cone	Standard flat disc	Throttling device locking device	Balancing plug and disc	R-PTFE soft seat standard disc	R-PTFE soft seat locking device	R-PTFE soft seat throttling plug and disc	Stellite seat	Single ply	Twin ply
Cast iron	BSA1		●							●	
	BSA1 RPTFE						●				●
	BSA1B/D					●					●
	BSA1T				●						●
	BSA1T RPTFE								●		●
SG iron	BSA2	PN16	●								●
		PN25	●								●
	BSA2 RPTFE	PN16					●				●
	BSA2B/D					●					●
	BSA2T	PN16			●						●
		PN25			●						●
Cast steel	BSA2T RPTFE	PN16						●			●
		PN25						●			●
	BSA3		●								●
	BSA3 RPTFE						●				●
Cast steel	BSA3B/D					●					●
	BSA3T				●						●
	BSA3T RPTFE							●			●
	BSA6T				●						●
Stainless steel	BSA64T (carbon steel bonnet)				●						●
	A3S		●							●	●

● DN125 and above only

BSA1 BSA1T



Sizes and pipe connections

DN15, 20, 25, 32, 40, 50, 65, 80, 100, 125, 150 and 200
Flanged EN 1092 / ISO 7005 PN16 and JIS B 2210 / KS B 1511 10K
Face-to-face EN 558

Materials

Body	Cast iron	DIN 1691 GG 25
Bonnet	SG iron	DIN 1693 GGG 40.3
Bellows	Stainless steel	DIN 17440 X6 Cr Ni Ti 1810
Handwheel	Pressed steel	BS 1449 CR4
Bonnet bolts	Steel	DIN 931 Gr. 5.6
Internals	Graphite / stainless steel	

Pressure/temperature limits

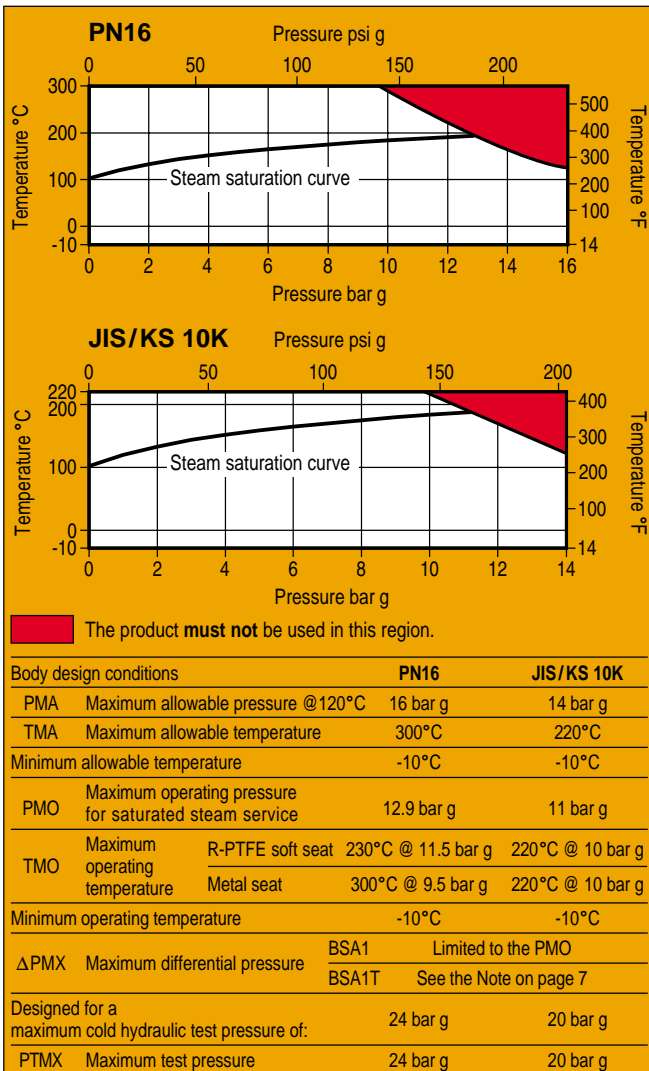

BSA2 BSA2T



Sizes and pipe connections

DN15, 20, 25, 32, 40, 50, 65, 80, 100, 125, 150, 200 and 250* (*PN25 only)
Flanged EN 1092 / ISO 7005 PN16 and PN25
Face-to-face EN 558

Materials

Body	SG iron	DIN 1693 GGG 40.3
Bonnet	SG iron	DIN 1693 GGG 40.3
Bellows	Stainless steel	DIN 17440 X6 Cr Ni Ti 1810
Handwheel	Pressed steel	BS 1449 CR4
Bonnet studs	Steel	DIN 17240 24 Cr Mo 5
Bonnet nuts	Steel	DIN 17240 Ck 35
Internals	Graphite / stainless steel	

Pressure/temperature limits

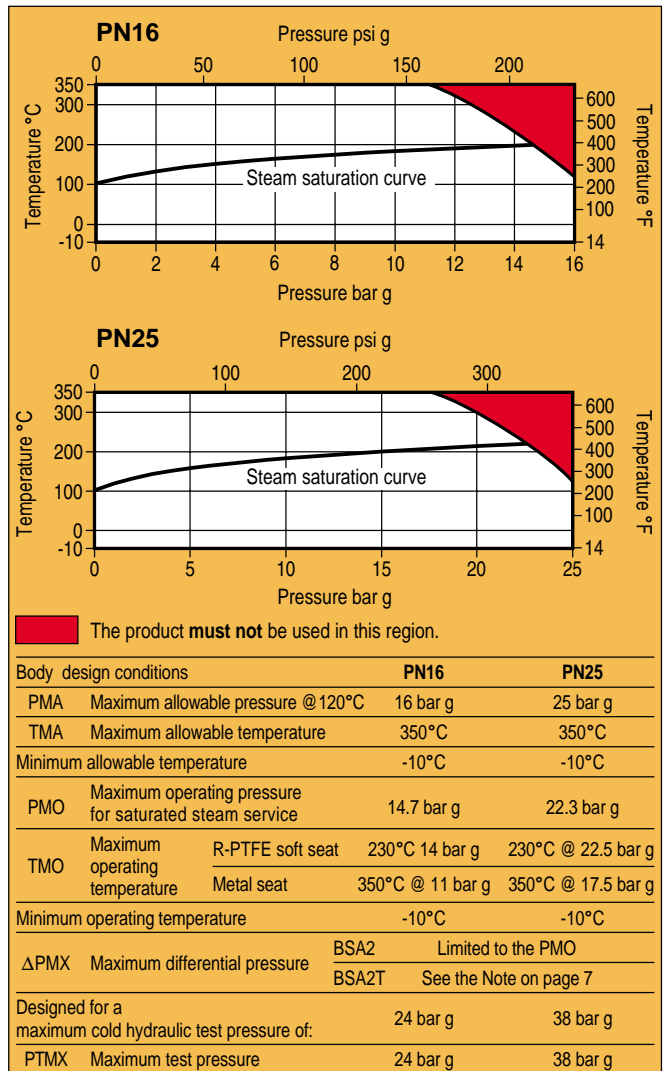

BSA3 BSA3T (DIN)



Sizes and pipe connections

DN15, 20, 25, 32, 40, 50, 65, 80, 100, 125, 150 and 200
 Flanged EN 1092 / ISO 7005 PN40 (DN15 - DN150)
 Flanged EN 1092 / ISO 7005 PN25 (DN200)
 Face-to-face EN 558

Materials

Body	Cast steel	GP240 GH (1.0619+N)
Bonnet (DN15 - DN80)	Forged steel	DIN 17243 C 22.8
Bonnet (DN100 - DN200)	Cast steel	GP240 GH (1.0619+N)
Bellows	Stainless steel	DIN 17440 X6 Cr Ni Ti 1810
Handwheel	Pressed steel	BS 1449 CR4
Bonnet studs	Steel	DIN 17240 24 Cr Mo 5
Bonnet nuts	Steel	DIN 17240 Ck 35
Internals	Graphite / stainless steel	

Pressure/temperature limits

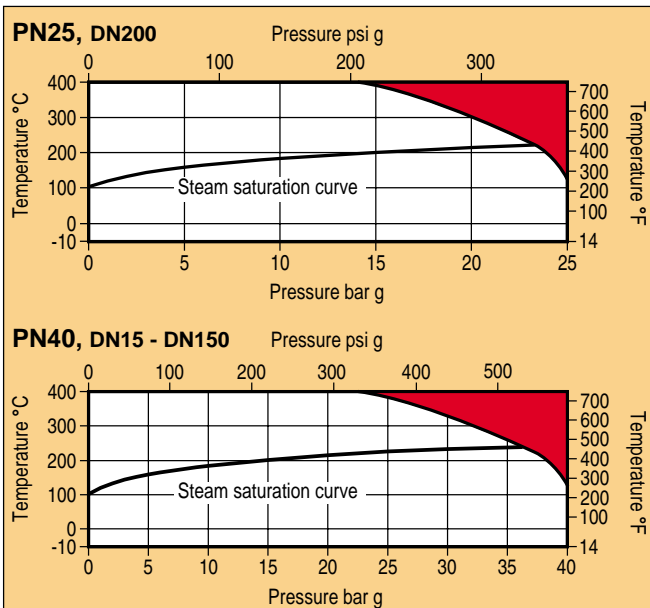

PN25, DN200

PN40, DN15 - DN150

The product **must not** be used in this region.

Body design conditions	PN25 (DN200)	PN40 (DN15 - DN150)
PMA Maximum allowable pressure @120°C	25 bar g	40 bar g
TMA Maximum allowable temperature	400°C	400°C
Minimum allowable temperature	-10°C	-10°C
PMO Maximum operating pressure for saturated steam service	23.2 bar g	36.1 bar g*
TMO Maximum operating temperature	R-PTFE soft seat	230°C @ 23 bar g
	Metal seat	400°C @ 14 bar g
Minimum operating temperature	-10°C	-10°C
ΔPMX Maximum differential pressure	BSA3	Limited to the PMO
	BSA3T	See the Note on page 7
Designed for a maximum cold hydraulic test pressure of:	38 bar g	60 bar g
PTMX Maximum test pressure	38 bar g	60 bar g

* Maximum operating pressure is limited to 27 bar g for the R-PTFE soft seat version only

BSA3 BSA3T (ANSI)



Sizes and pipe connections

Size 1/2", 3/4", 1", 1 1/2", 2", 3", 4", 6"* and 8"* (*ANSI 300 only)
 Flanged ANSI B 16.5 / BS 1560 Class 150 and 300
 and JIS B 2210 / KS B 1511 20K
 Face-to-face ANSI B 16.10

Materials

Body	Cast steel	ASTM A 216 WCB
Bonnet (DN15 - DN80)	Forged steel	ASTM A 105+N
Bonnet (DN100 - DN200)	Cast steel	ASTM A 216 WCB
Bellows	Stainless steel	DIN 17440 X6 Cr Ni Ti 1810
Handwheel	Pressed steel	BS 1449 CR4
Bonnet studs	Steel	ASTM A 193 B7
Bonnet nuts	Steel	ASTM A 194 2 H
Internals	Graphite / stainless steel	

Pressure/temperature limits

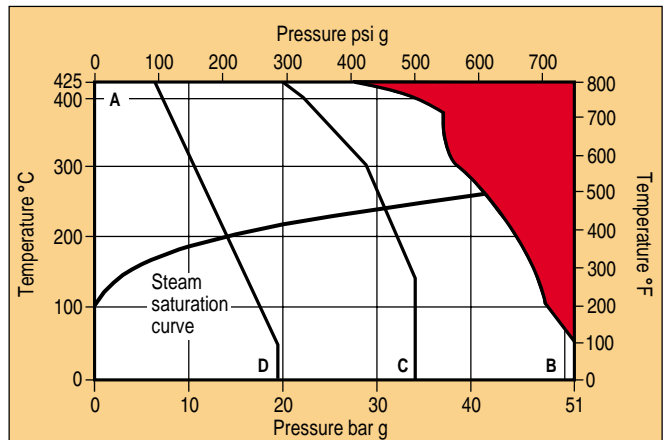

The product **must not** be used in this region.

- A - B Flanged ANSI 300
- A - C Flanged JIS / KS 20K
- A - D Flanged ANSI 150

Body design conditions	ANSI 150	ANSI 300	JIS/KS 20K
PMA Maximum allowable pressure	19 bar g @ 50°C	51 bar g @ 38°C	34 bar g @ 140°C
TMA Maximum allowable temperature	425°C	425°C	425°C
Minimum allowable temperature	-10°C	-10°C	-10°C
PMO Maximum operating pressure for saturated steam service	14 bar	30.7 bar*	41.6 bar*
TMO Maximum operating temperature	R-PTFE soft seat	230°C @ 13 bar g	230°C @ 32 bar g
	Metal seat	425°C @ 6.5 bar g	425°C @ 20 bar g
Minimum operating temperature	0°C	0°C	0°C
ΔPMX Maximum differential pressure	BSA3	Limited to the PMO	
	BSA3T	See the Note on page 7	
Designed for a maximum cold hydraulic test pressure of:	31 bar g	77 bar g	50 bar g
PTMX Maximum test pressure	31 bar g	77 bar g	50 bar g

* Maximum operating pressure is limited to 27 bar g for the R-PTFE soft seat version only

BSA6T BSA64T



Sizes and pipe connections

DN15, 20, 25, 32, 40, 50, 65, 80 and 100
Flanged EN 1092 PN40
Face-to-face EN 558

Materials

Body and seat	Stainless steel	EN 10213 1.4408 ASTM A351 CF8M	
Bonnet	BSA6T	Stainless steel (DN15 - DN80)	EN 10222 1.4571
		Stainless steel (DN100)	EN 10213 1.4581
	BSA64T	Forged steel (DN15 - DN80)	DIN 17243 C22.8
		Cast steel (DN100)	GP240 GH (1.0619+N)
Bellows	Stainless steel	DIN 17440 1.4541	
Handwheel	Pressed steel	BS 1449 CR4	
Bonnet studs	Stainless steel	A4-70	
Bonnet nuts	Stainless steel	A4	
Internals	Graphite / stainless steel		

Pressure/temperature limits

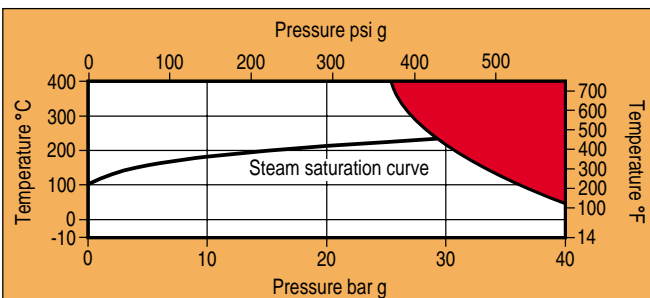

 The product **must not** be used in this region.

Body design conditions		PN40
PMA	Maximum allowable pressure @50°C	40 bar g
TMA	Maximum allowable temperature	400°C
Minimum allowable temperature		-10°C
PMO	Maximum operating pressure for saturated steam service	Metal seat 29.8 bar g @ 236°C
		R-PTFE soft seat 27 bar g @ 230°C
TMO	Maximum operating temperature	Metal seat 400°C @ 25.6 bar g
		R-PTFE soft seat 230°C @ 27.0 bar g
Minimum operating temperature		-10°C
ΔPMX	Maximum differential pressure	See the Note on page 7
Designed for a maximum cold hydraulic test pressure of:		60 bar g
PTMX	Maximum test pressure	60 bar g

A3S



Sizes and pipe connections

½", ¾", 1", 1¼", 1½" and 2"
Screwed BSP (BS 21 parallel), NPT
Socket weld to BS 3799/ANSI B 16.11

Materials

Body	Forged steel	ASTM A 105
Bonnet	Forged steel	ASTM A 105
Bellows	Stainless steel	ASTM A 479 Type 321
Handwheel	Carbon steel	
Body bolts	Carbon steel	ASTM A 276 B7
Internals	Stainless steel / graphite stellite	

Pressure/temperature limits

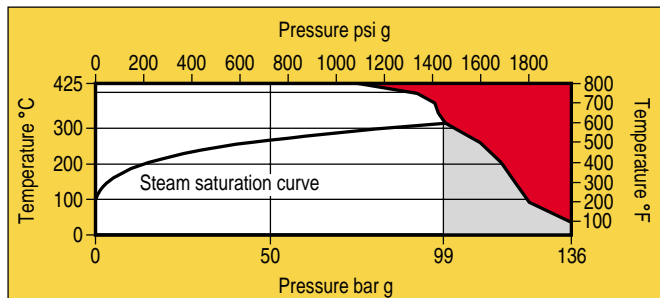

 The product **must not** be used in this region.

 The product should not be used in this region as damage to the internals will occur.

Body design conditions		Class 800
PMA	Maximum allowable pressure @38°C	136 bar g
TMA	Maximum allowable temperature	425°C
Minimum allowable temperature		0°C
PMO	Maximum operating pressure for saturated steam service	300°C @ 99 bar g
TMO	Maximum operating temperature	400°C @ 69 bar g
Minimum operating temperature		0°C
ΔPMX	Maximum differential pressure	Limited to the PMO
Designed for a maximum cold hydraulic test pressure of:		212 bar g
PTMX	Maximum test pressure	212 bar g

Flow data for bellows sealed stop valves

BSA1, BSA2 (PN16 only) and BSA3 (DN125 and above)

Size	DN15 ½"	DN20 ¾"	DN25 1"	DN32 1¼"	DN40 1½"	DN50 2"	DN65 2½"	DN80 3"	DN100 4"	DN125 5"	DN150 6"	DN200 8"	DN250 10"
K_v	4	7	12	19	30	47	77	120	193	288	410	725	1 145

For conversion: C_v (UK) = K_v x 0.97

C_v (US) = K_v x 1.17

BSA1T, BSA2T, BSA3T, BSA6T and BSA64T

Size	DN15 ½"	DN20 ¾"	DN25 1"	DN32 1¼"	DN40 1½"	DN50 2"	DN65 2½"	DN80 3"	DN100 4"	DN125 5"	DN150 6"	DN200 8"	DN250 10"
Hand-wheel rotations	K _v values for given handwheel rotations tested to EN 60534-2-3 Water at 20°C												
0	0	0	0	0	0	0	0	0	0	0	0	0	0
0.5	1.2	1.2	1.4	2.2	4.4	4.1	5.6	10.4	12.0	21	28	66	110
1	1.7	1.7	2.0	3.7	5.0	5.0	7.0	11.5	14.3	23	30	81	140
1.5	2.7	2.9	2.9	5.0	5.5	6.0	9.2	13.6	24.5	26	33	97	150
2	3.6	4.0	4.6	7.9	7.6	7.2	11.6	16.3	34.1	42	46	111	165
2.5	4.4	5.3	6.4	10.6	11.0	9.7	12.4	18.5	59.6	67	65	149	190
3	5.4	6.6	8.5	13.8	14.7	14.1	13.0	21.1	86.2	94	90	199	225
4			10.6	17.0	22.6	24.4	25.2	24.5	123.0	140	152	302	330
4.5			11.2	18.3	24.4	29.4	32.5	29.0	139.0	181	177	355	451
5			11.9	19.6	27.2	37.0	43.6	39.1	164.1	185	216	403	460
6					28.9	46.2	60.2	61.0	179.0	220	264	455	600
6.5					29.1	47.0	63.0	69.0	186.0	230	288	480	641
6.7					29.3	47.2	64.3	73.0		235	293	487	656
7							65.9	78.0		241	305	495	678
8							71.2	90.0		259	337	507	738
8.5							74.6	92.0			348	522	760
9.5								99.0			369		793
10								101.6					805
10.7													827

To convert K_v to volume flowrate in m³/h:- $\dot{Q} = K_v \times \sqrt{\Delta P}$

Where: \dot{Q} = Volume flow in cubic m/h

ΔP = Pressure drop in bar

Maximum differential pressure

Note:	The maximum permissible differential pressure in throttling function:			
	DN15 - DN80 2.0 bar	DN100 - DN125 1.5 bar	DN150 1.0 bar	DN200 - DN250 0.8 bar

A3S

Size	½"	¾"	1"	1¼"	1½"	2"
K_v	1.3	3.2	5.8	9.0	17.0	19.2

For conversion: C_v (UK) = K_v x 0.97

C_v (US) = K_v x 1.17

Dimensions and weights (approximate) in mm and kg

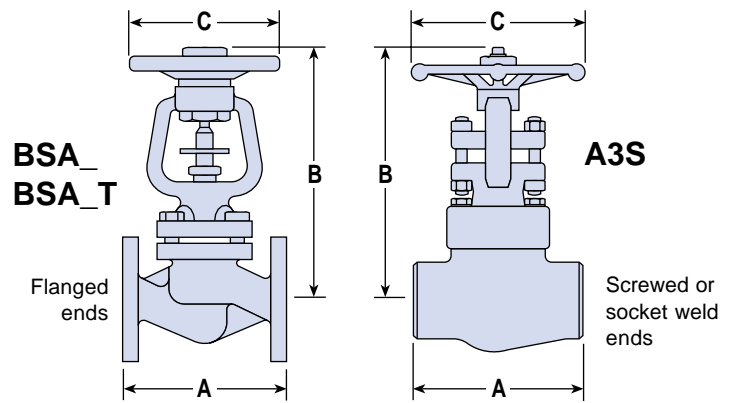

BSA_ and BSA_T

Dimensions		DN15	DN20	DN25	DN32	DN40	DN50	DN65	DN80	DN100	DN125	DN150	DN200	DN250
		½"	¾"	1"	1¼"	1½"	2"	2½"	3"	4"	5"	6"	8"	10"
A	PN	130	150	160	180	200	230	290	310	350	400	480	600	730
	ANSI 150	108	117	127	-	165	203	-	241	292	-	-	-	-
	ANSI 300	152	178	203	-	229	267	-	317	356	-	445	559	-
	JIS / KS 10K	133	153	163	183	203	229	293	309	349	395	479	592	-
	JIS / KS 20K	152	178	200	-	224	259	-	304	340	-	428	537	-
B		205	205	217	217	243	243	263	287	383	416	450	622	763
C		125	125	125	125	200	200	200	200	315	315	315	500	500
Weights		DN15	DN20	DN25	DN32	DN40	DN50	DN65	DN80	DN100	DN125	DN150	DN200	DN250
		½"	¾"	1"	1¼"	1½"	2"	2½"	3"	4"	5"	6"	8"	10"
BSA1 and BSA1T		4	4	5	7	10	12	16	21	36	52	75	145	-
BSA2 and BSA2T		4	4	5	7	10	12	16	21	36	52	75	145	180
BSA3	PN	4	5	6	8	11	14	19	26	44	64	88	180	-
	ANSI 150	5	6	8	-	10	12	-	25	41	-	-	-	-
	ANSI 300	6	7	9	-	11	15	-	29	49	-	94	193	-
	JIS/KS 20K	6	7	9	-	11	15	-	29	49	-	94	193	-
BSA6T and BSA64T		4	5	6	8	11	14	19	26	44	-	-	-	-

A3S

Dimensions	½"	¾"	1"	1¼"	1½"	2"
A	80	90	110	127	155	170
B (valve open)	136	144	167	194	220	230
C	70	90	110	110	130	180
Weights	½"	¾"	1"	1¼"	1½"	2"
A3S	1.7	2.3	3.6	5.9	8.5	11.6

How to order Example: 1 off Spirax Sarco DN25 BSA2 bellows sealed stop valve having flanged PN16 connections.
Note: Should the differential pressure exceed those listed against the respective sizes in the table below, then please ensure a balancing disc is specified for use in the valve (see page 2, Optional disc assemblies).

Size	DN125	DN150	DN200	DN250
Differential pressure (bar)	25	17	10	6

Some of the products shown may not be available in certain markets.

Spirax-Sarco Limited, Charlton House,
 Cheltenham, Gloucestershire, GL53 8ER UK.
 Tel: +44 (0)1242 521361 Fax: +44 (0)1242 573342
 E-mail: Enquiries@SpiraxSarco.com
 Internet: www.SpiraxSarco.com

© Copyright 2003 Spirax Sarco is a registered trademark of Spirax-Sarco Limited

spirax
sarco

SB-P137-01

ST Issue 5